



Since 1889

CHICAGO-ALLIS MFG. CORP.

HYDRAULIC AND PNEUMATIC PACKINGS



FLANGE PACKING



"U" PACKING

- Homogeneous Rubber
- Fabric
- Leather
- Teflon®



CUP PACKING

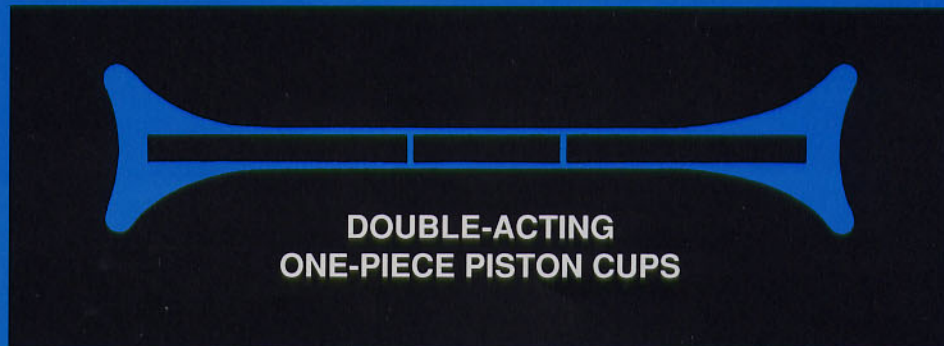

DOUBLE-ACTING
ONE-PIECE PISTON CUPS



VEE PACKING



"O" RINGS

BACKUP WASHERS

"ARCHITECTS FOR SOLVING SEALING PROBLEMS"

ONE-PIECE DOUBLE-ACTING PISTON CUPS—A piston type double-cup packing in a single unit . . . especially compounded homogeneous rubbers bonded to a steel insert with a protective zinc coating or a solid brass insert. Lips are designed to maintain uniform pressure on the cylinder walls, insuring constant sealing action. Used widely on cylinders, pumps, and valves . . . air, water, or oil, these units serve the same purpose as far more complicated and expensive pistons, and provide the maximum in design simplicity, economy, long life, and dependable service.



CUP PACKING— is a molded packing having a single sidewall which seals at its outer periphery . . . generally used on the head of a piston, plunger or ram subject to reciprocating motion. With proper clearance between the follower plate and the inside of the cup, the sidewall of the cup provides a sliding fit in the cylinder, creating a dynamic seal. The cup is installed so that the sealing lip opposes the applied pressure. The dynamic seal between the cup and the cylinder wall is made through contact of the cup sidewall against the cylinder upon the application of pressure.



FLANGE PACKING— is a molded packing having a single sidewall which seals at its inner periphery . . . generally used on a piston rod or shaft to retain liquids under pressure or to repel dust or foreign matter. The inside surface or lip of the flange forms a mechanical packing seal against the piston rod, plunger, or shaft.



"U" PACKING— is a molded packing having a cross-section shaped like the letter U . . . generally used on applications involving a reciprocating shaft or plunger. They are usually installed in a recess within a cylinder, or as a piston seal. The internal pressure medium causes the outer sidewall to move outward and the inner sidewall to move inward, simultaneously sealing on both inside and outside peripheries. With the pressure acting on the inner surface in all directions, the "U" packing is statically balanced and fixed in position, making it the simplest of all packing to install and maintain.



VEE PACKINGS— are molded, double lipped packings having a cross-section resembling the letter "V" and sealing on both the inner and outer peripheries . . . generally used in sets consisting of a series of individual Vee packings stacked or nested together, complete with top and bottom adapters. The multiplicity of sealing lips provides for greatly increased sealing efficiency and sensitivity against a wide range of pressures and mediums . . . and extended service life. Versatility of application permits use for low or high pressures, as an inside piston seal, as an outside stuffing box seal, against either reciprocating, rotating or oscillating motions. In some instances individual packing rings are split to provide easier, faster assembly and maintenance.

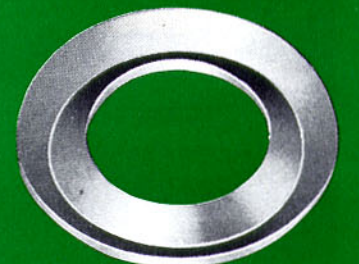

"O" RINGS AND BACKUP WASHERS— "O" rings are molded packings having a cross-section resembling the letter "O." The "O" ring depends upon compression to provide the seal. With proper design, "O" rings may be adapted to static, reciprocating, rotating, and oscillating applications. "O" rings are produced in a wide variety of compounds to accommodate a broad range of conditions of pressures, temperatures, and mediums.

Backup washers — are used in conjunction with "O" rings and other types of packings to prevent extrusion under high pressures.



CHICAGO-ALLIS

CAV

HOMOGENEOUS RUBBER
HYDRAULIC AND PNEUMATIC
CUP PACKINGS

for higher pressures • up to 5000 psi

Type CAV Cup Packings with a unique "straight-wall" design provides maximum simplicity, adaptability, and economy for accommodating reciprocating motion in such units as hydraulic and pneumatic cylinders, sealing both the piston and the rod. Originally designed to supplement type CAU Cup Packings, where pressures and/or design dictated the use of a comparable packing for a more critical application, the CAV Cup Packings accommodate higher pressures up to 5000 psi and require less space. In some cases they are interchangeable with "O" rings. They are also excellent static seals, and especially advantageous for applications where there is a slight movement or vibration between the parts. Where the speed of reciprocation is low, CAV Cup Packings may be used for a combination of reciprocating motions or for rotation only. Standard CAV Cup Packings are made of General Purpose 80 Durometer which has excellent properties for accommodating a wide range of operating conditions and has an especially high resistance to hydraulic oils and lubricated air.

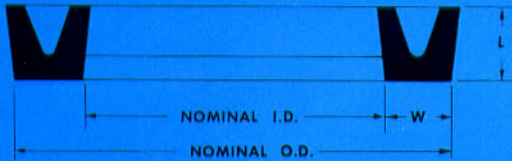

STANDARD SIZES

PART NO.	WL	NOMINAL SIZE	
		ID	OD
*332-CAV-0516	3/32	1/8	5/16
18-CAV-01132	1/8	3/32	11/32
332-CAV-038*	3/32	3/16	3/8
18-CAV-01332*	1/8	5/32	13/32
332-CAV-0716*	3/32	1/4	7/16
18-CAV-012*	1/8	1/4	1/2
332-CAV-012*	3/32	5/16	1/2
18-CAV-058*	1/8	3/8	5/8
332-CAV-058	3/32	7/16	5/8
18-CAV-01116*	1/8	7/16	11/16
18-CAV-034*	1/8	1/2	3/4
332-CAV-034*	3/32	9/16	3/4
532-CAV-01316	5/32	1/2	13/16
18-CAV-01316*	1/8	9/16	13/16
18-CAV-078*	1/8	5/8	7/8
18-CAV-01516*	1/8	11/16	15/16
316-CAV-100	3/16	5/8	1
532-CAV-100*	5/32	11/16	1
18-CAV-100*	1/8	3/4	1
18-CAV-1116*	1/8	13/16	11/16
18-CAV-118*	1/8	7/8	13/16
532-CAV-114*	5/32	15/16	11/4
18-CAV-114*	1/8	1	11/4
532-CAV-1516*	5/32	1	15/16
316-CAV-138*	3/16	1	13/8
18-CAV-138*	1/8	11/8	13/8

PART NO.	WL	NOMINAL SIZE	
		ID	OD
14-CAV-112	1/4	1	11/2
532-CAV-112*	5/32	13/16	11/2
532-CAV-1916*	5/32	11/4	19/16
316-CAV-158*	3/16	11/4	15/8
532-CAV-11116*	5/32	13/8	111/16
316-CAV-134*	3/16	13/8	13/4
532-CAV-134*	5/32	17/16	13/4
532-CAV-11316	5/32	11/2	113/16
133-CAV-15364*	133	19/16	153/64
316-CAV-178*	3/16	11/2	17/8
316-CAV-200*	3/16	15/8	2
316-CAV-218*	3/16	13/4	21/8
14-CAV-2316*	1/4	111/16	23/16
14-CAV-214*	1/4	13/4	21/4
316-CAV-214*	3/16	17/8	21/4
316-CAV-2516	3/16	115/16	25/16
316-CAV-238*	3/16	2	23/8
14-CAV-212	1/4	2	21/2
316-CAV-212*	3/16	21/8	21/2
316-CAV-258	3/16	21/4	25/8
14-CAV-234	1/4	21/4	23/4
316-CAV-278*	3/16	21/2	27/8
732-CAV-300*	7/32	25/16	3
732-CAV-3316*	7/32	23/4	33/16
732-CAV-314*	7/32	213/16	31/4
732-CAV-3716*	7/32	3	37/16

PART NO.	WL	NOMINAL SIZE	
		ID	OD
516-CAV-312	5/16	27/8	31/2
732-CAV-312*	7/32	31/16	31/2
316-CAV-358	3/16	31/4	35/8
732-CAV-334	7/32	35/16	33/4
14-CAV-400*	1/4	31/2	4
14-CAV-414*	1/4	33/4	41/4
14-CAV-412*	1/4	4	41/2
14-CAV-434*	1/4	41/4	43/4
516-CAV-500	5/16	43/8	5
932-CAV-500*	9/32	47/16	5
14-CAV-500*	1/4	41/2	5
932-CAV-518	9/32	49/16	51/8
14-CAV-514	1/4	43/4	51/4
932-CAV-5916*	9/32	5	59/16
516-CAV-600*	5/16	53/8	6
516-CAV-618	5/16	51/2	61/8
38-CAV-614	3/8	51/2	61/4
516-CAV-614*	5/16	55/8	61/4
516-CAV-612	5/16	57/8	61/2
516-CAV-700*	5/16	63/8	7
516-CAV-800*	5/16	73/8	8
1132-CAV-1000	11/32	95/16	10
38-CAV-1200*	3/8	111/4	12
12-CAV-1400	1/2	13	14
12-CAV-1500	1/2	14	15

* viton molds available. (Standard cups are made of General Purpose 80 Durometer). Upon request viton,® silicone, ethylene propylene tri-polymer (e.p.t.) and other exotic synthetic rubbers may be available depending upon shrinkage characteristics in molding from existing molds.

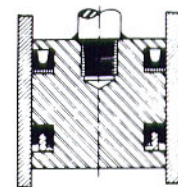
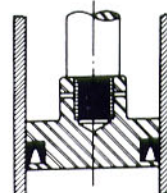
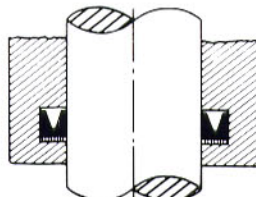
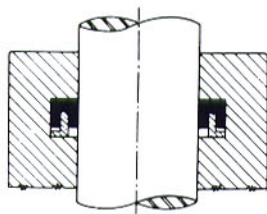

Back up washers are available, on request, cut from compressed vegetable fiber or leather.

HOMOGENEOUS RUBBER HYDRAULIC AND PNEUMATIC CUP PACKINGS

for low pressures • up to 750 psi

Type CAU Cup Packings provide the same simplicity, adaptability, and economy features as the CAV Cups for low pressure applications. They are excellent for accommodating reciprocating motion in hydraulic and pneumatic cylinders and similar units, being used for sealing both the piston and the rod . . . where pressures do not exceed 750 psi.

Originally standardized as an Army-Navy design low pressure seal, CAU Cups are now used in a broad variety of applications where users have found this type most adaptable to their specific conditions. They are often used as static seals for applications involving slight movement or vibration between parts. Also, where the speed of reciprocation is low they accommodate a combination of reciprocating and rotating motion. In many instances they have provided most effective sealing for rotating motion only where the speed is low.

Standard CAU Cup Packings are made of General Purpose 70 Durometer which has an especially high resistance to hydraulic oils and lubricated air and excellent properties for accommodating a wide range of operating conditions.

CAU

CHICAGO-ALLIS

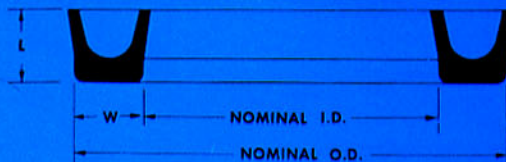
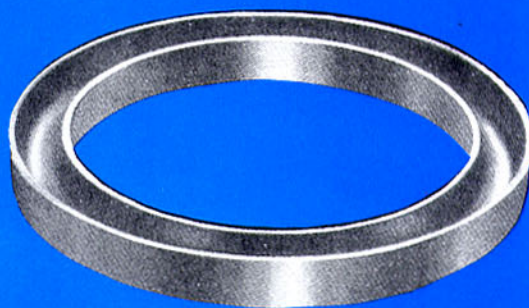

STANDARD SIZES

D-26-R DASH NO.	W&L	NOMINAL	
		I.D.	O.D.
1	3/16	1/8	1/2
2	3/16	3/16	9/16
3	3/16	1/4	5/8
4	3/16	5/16	11/16
5	3/16	3/8	3/4
6	3/16	7/16	13/16
7	3/16	1/2	7/8
8	1/4	1/4	3/4
9	1/4	5/16	13/16
10	1/4	3/8	7/8
11	1/4	7/16	15/16
12	1/4	1/2	1
13	1/4	9/16	11/16
14	1/4	5/8	13/8
15	1/4	11/16	13/16

D-26-R DASH NO.	W&L	NOMINAL	
		I.D.	O.D.
16	1/4	3/4	1 1/4
17	1/4	13/16	15/16
18	1/4	7/8	1 3/8
19	1/4	15/16	17/16
20	1/4	1	1 1/2
21	1/4	11/16	19/16
22	1/4	11/8	1 5/8
23	1/4	13/16	1 11/16
24	1/4	1 1/4	1 3/4
25	5/16	1 1/4	1 7/8
26	5/16	1 3/8	2
27	5/16	1 1/2	2 1/8
28	5/16	1 5/8	2 1/4
29	5/16	1 3/4	2 3/8
30	5/16	1 7/8	2 1/2

D-26-R DASH NO.	W&L	NOMINAL	
		I.D.	O.D.
31	5/16	2	2 5/8
32	5/16	2 1/8	2 3/4
33	5/16	2 1/4	2 7/8
34	5/16	2 3/8	3
35	5/16	2 1/2	3 1/8
36	3/8	2 1/2	3 1/4
37	3/8	2 5/8	3 3/8
38	3/8	2 3/4	3 1/2
39	3/8	2 7/8	3 5/8
40	3/8	3	3 3/4
41	1/2	1/8	3/8
42	1/2	3/16	7/16
43	1/2	1/4	1/2
44	1/2	5/16	9/16
45	1/2	3/8	5/8

D-26-R DASH NO.	W&L	NOMINAL	
		I.D.	O.D.
46	1/2	7/16	11/16
47	1/2	1/2	3/4
48	3/16	5/8	1
49	3/16	3/4	1 1/8
50	3/16	7/8	1 1/4
51	3/16	1	1 3/8
52	3/16	1 1/8	1 1/2
53	3/16	1 1/4	1 5/8
54	3/8	3/4	4
55	3/8	4 1/4	5
56	7/16	5 1/8	6
56 A	3/8	5 1/4	6
57	1/2	7	8
58	1/2	9	10
59	1/2	11	12

(Standard Cups are made of General Purpose 70 Durometer). Upon request viton, silicone, ethylene propylene, and other exotic synthetic rubbers may be available depending upon shrinkage characteristics in molding from existing molds.

APPLICATION DATA

INTERNAL

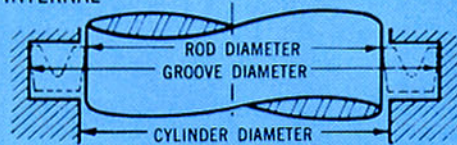

EXTERNAL

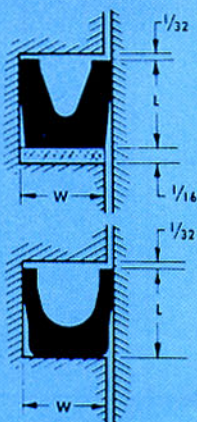
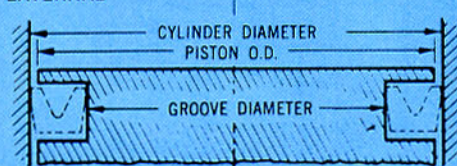

GROOVE DETAIL INTERNAL OR EXTERNAL

It is suggested that external or internal grooves be designed to nominal diameter of the CAV and CAU cup packings selected for the specific application. The length of the grooves should exceed the "L" dimension by 1/32". When back-up washers are supplied they will be 1/16" thick unless otherwise requested. Also, it is recommended that the diametral clearance should not exceed .010" under any circumstances. And, for elevated pressures the diametral clearance should be reduced . . . for 500 psi to .008", and a further reduction of approximately .002" per 1500 psi for higher pressures.

The wear surface should be finished to 15 micro inch finish or better.

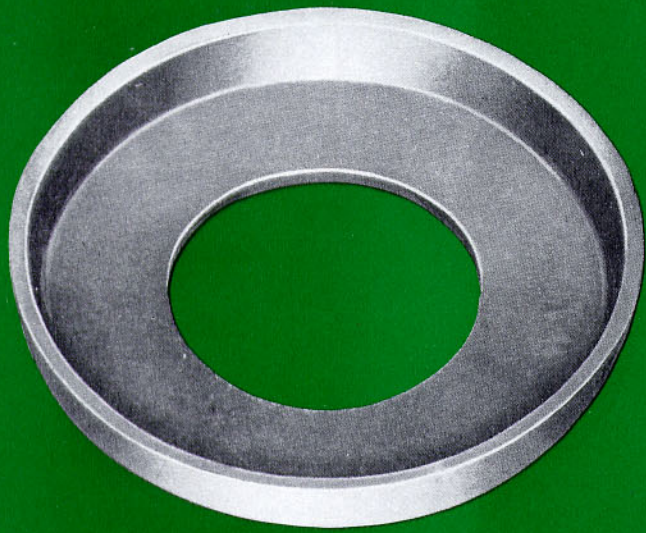

CHICAGO-ALLIS CUP PACKING

For single and double-acting cylinders or pistons. Pressures from 0 to 3000 P. S. I.

Cup packings are used for a wide range of hydraulic and pneumatic services at low and high temperatures. They are available in leather, rubber, fabric and teflon (upon application) materials. Leather cups are available in oak, chrome, or retan tannages—selection determined by the specific operating conditions. Cups are also available in a wide variety of homogeneous synthetic rubber and

fabrics with synthetic impregnations. Send in details including conditions of temperature, pressure, and medium to the Chicago-Allis Sales Department in Chicago for complete analysis and recommendations through our Engineering Staff. Chicago-Allis field representatives are qualified to assist you with counsel on your requirements.

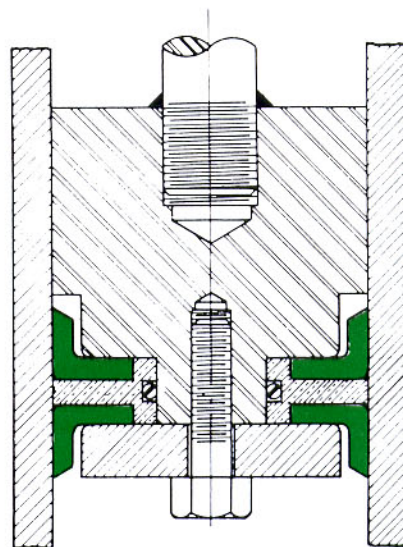
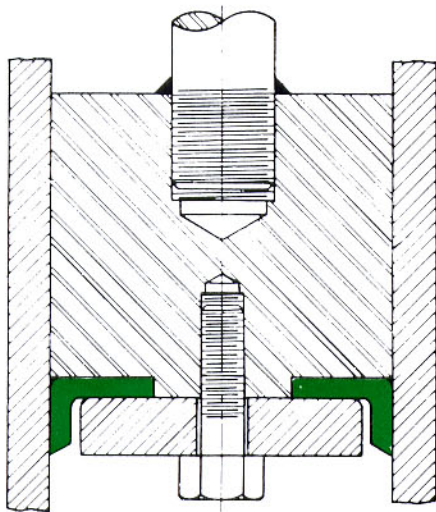

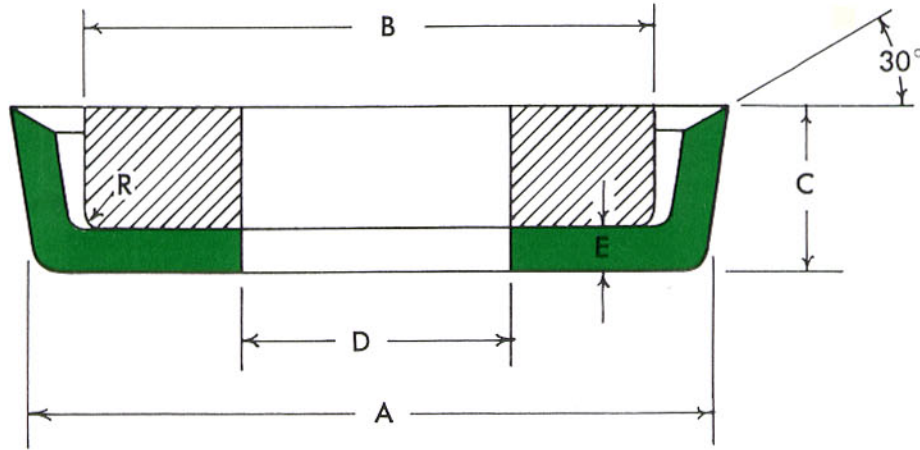

D-12 DASH NO.	A	C	*D MIN.	E +.020 -.000	INSIDE PLATE	
					B	R
10	1	1/2	3/8	3/32	.708	1/32
11	1-1/8	1/2	3/8	3/32	.835	1/32
12	1-1/4	1/2	3/8	3/32	.961	1/32
13	1-3/8	1/2	3/8	3/32	1.085	1/32
14	1-1/2	1/2	1/2	1/8	1.203	1/32
15	1-5/8	1/2	1/2	1/8	1.332	1/32
16	1-3/4	1/2	1/2	1/8	1.459	1/32
17	1-7/8	1/2	1/2	1/8	1.584	1/32
18	2	1/2	1/2	1/8	1.709	1/32
19	2-1/8	1/2	1/2	1/8	1.832	1/32
20	2-1/4	1/2	1/2	1/8	1.959	1/32
21	2-3/8	1/2	1/2	1/8	2.082	1/32
22	2-1/2	1/2	1/2	1/8	2.203	1/32
23	2-5/8	1/2	1/2	1/8	2.334	1/32
24	2-3/4	1/2	1/2	1/8	2.448	1/32
25	2-7/8	1/2	1/2	1/8	2.585	1/32
26	3	5/8	3/4	5/32	2.641	1/32
27	3-1/8	5/8	3/4	5/32	2.752	1/32
28	3-1/4	5/8	3/4	5/32	2.897	1/32
29	3-3/8	5/8	3/4	5/32	3.022	1/32
30	3-1/2	5/8	3/4	5/32	3.140	1/16
31	3-5/8	5/8	3/4	5/32	3.267	1/16
32	3-3/4	5/8	3/4	5/32	3.390	1/16
33	3-7/8	5/8	3/4	5/32	3.516	1/16
34	4	5/8	3/4	5/32	3.643	1/16
35	4-1/4	5/8	3/4	5/32	3.891	1/16
36	4-1/2	5/8	1	5/32	4.155	1/16
37	4-3/4	5/8	1	5/32	4.393	1/16
38	5	3/4	1-1/2	3/16	4.579	1/16
39	5-1/4	3/4	1-1/2	3/16	4.842	1/16
40	5-1/2	3/4	1-1/2	3/16	5.074	1/8
41	5-3/4	3/4	1-1/2	3/16	5.332	1/8
42	6	3/4	1-1/2	3/16	5.579	1/8
43	6-1/4	3/4	1-1/2	3/16	5.826	1/8
44	6-1/2	3/4	2	3/16	6.073	1/8

D-12 DASH NO.	A	C	*D MIN.	E +.020 -.000	INSIDE PLATE	
					B	R
45	6-3/4	3/4	2	3/16	6.325	1/8
46	7	3/4	2	3/16	6.585	1/8
47	7-1/4	3/4	2	3/16	6.821	1/8
48	7-1/2	3/4	2-1/2	3/16	7.084	1/8
49	7-3/4	3/4	2-1/2	3/16	7.331	1/8
50	8	1	3-3/4	1/4	7.467	1/8
51	8-1/2	1	3-3/4	1/4	7.959	1/8
52	9	1	4	1/4	8.459	1/8
53	9-1/2	1	4	1/4	8.953	1/8
54	10	1-1/4	5	1/4	9.445	1/8
55	10-1/2	1-1/4	5	1/4	9.943	1/8
56	11	1-1/4	5	1/4	10.441	1/8
57	11-1/2	1-1/4	5	1/4	10.941	1/8
58	12	1-1/4	5	1/4	11.440	1/8

Other sizes and thicknesses are available on request.

NOTES:

1. Minimum hole sizes (larger holes can be provided). "R" designates the radii of the packing and inside follower plate, cup walls are flared; therefore, lip diameter is actually oversize to the cylinder bore.
2. New designs should utilize standard commercial sizes. Other sizes are available for equipment already in use.

MAXIMUM CLEARANCE BETWEEN BACK FOLLOWER PLATE AND CYLINDER WALL

CYLINDER DIAMETER	UP TO 500 PSI	OVER 500 PSI
Under 3"	.006"	.004"
3" to 8"	.008"	.006"
8" to 10"	.010"	.008"
10" to 12"	.012"	.010"
12" to 16"	.014"	.012"

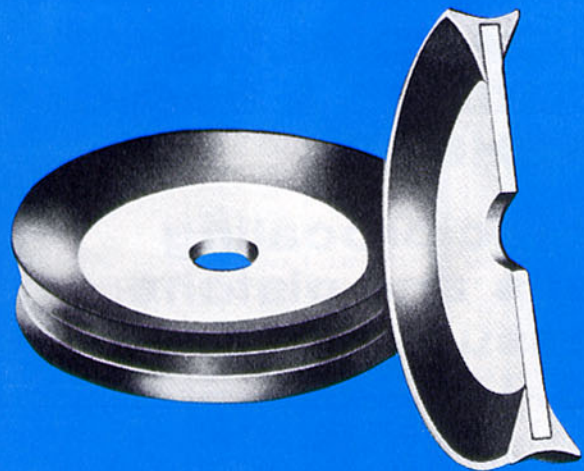

CHICAGO-ALLIS ONE-PIECE DOUBLE-ACTING PISTON CUP

This is a one-unit, double-cup, piston type packing, replacing the more complex and expensive multi-part assemblies. The lips are designed to maintain uniform pressure on the cylinder wall, insuring the most positive, constant sealing action. A variety of homogeneous rubbers are securely bonded to a steel insert with a protective zinc coating, or a solid brass insert. The specific synthetic rubber is selected according to the conditions of pressures, temperatures and mediums.

WIDELY USED BY ORIGINAL EQUIPMENT MANUFACTURERS—Because of the simple design, economy, and ease of maintenance, these pistons are widely used components in cylinders, pumps, and valves across the original equipment industries . . . and as replacement components for the more complex multi-part assemblies previously used in equipment already in the field. One-piece design provides precision control of eccentricity, resulting in longer service life.

Complete piston type cup of simple, one-piece construction serves the same purpose as multi-assembly units . . . more economically with easy maintenance, dependability, and long life.

Patent Nos. 2,309,466 and 2,386,668.

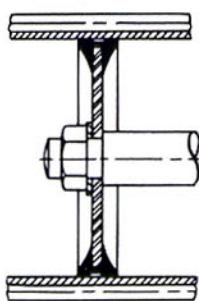
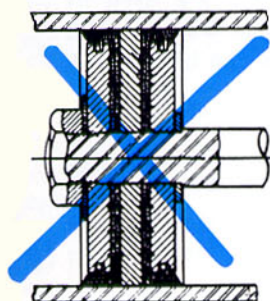

STANDARD SIZES

CYLINDER DIAMETER	PART NUMBER	MINIMUM CENTER HOLE	METAL PLATE THICKNESS	OVER-ALL CUP HEIGHT
1"	CB-28100	1/4"	3/32"	3/8"
1 1/8"	CB-28118	1/4"	3/32"	1/2"
1 1/4"	CB-28114	1/4"	3/32"	1/2"
1 3/8"	CB-281516	1/4"	3/32"	1/2"
1 3/8"	CB-28138	1/4"	3/32"	1/2"
1 1/2"	CB-28112	1/4"	3/32"	1/2"
1 5/8"	CB-28158	1/4"	3/32"	1/2"
1 3/4"	CB-28134	1/4"	3/32"	1/2"
1 7/8"	CB-28178	1/4"	3/32"	1/2"
2"	CB-28200	3/8"	1/8"	9/16"
2 1/8"	CB-28218	3/8"	1/8"	9/16"
2 1/4"	CB-28214	3/8"	1/8"	9/16"
2 3/8"	CB-28238	3/8"	1/8"	9/16"
2 1/2"	CB-28212	3/8"	1/8"	9/16"
2 5/8"	CB-28258	3/8"	1/8"	9/16"
2 3/4"	CB-28234	3/8"	1/8"	9/16"
3"	CB-28300	1/2"	1/8"	9/16"
3 1/8"	CB-28318	1/2"	1/8"	5/8"
3 1/4"	CB-28314	1/2"	1/8"	5/8"
3 1/2"	CB-28312	1/2"	3/16"	3/4"
3 3/8"	CB-28358	1/2"	3/16"	3/4"
3 3/4"	CB-28334	1/2"	3/16"	3/4"
4"	CB-28400	1/2"	3/16"	3/4"
4 1/4"	CB-28414	1/2"	3/16"	3/4"
4 1/2"	CB-28412	3/4"	3/16"	3/4"
5"	CB-28500	3/4"	1/4"	1 1/8"
5 1/2"	CB-28512	3/4"	1/4"	1 5/16"
6"	CB-28600	3/4"	1/4"	1 5/16"
6 1/2"	CB-28612	3/4"	1/4"	1 5/16"
7"	CB-28700	1 1/4"	1/4"	1"
8"	CB-28800	1 1/4"	1/4"	1"
9"	CB-28900	1 1/4"	1/4"	1"
10"	CB-281000	1 1/4"	1/4"	1"
12"	CB-281200	1 1/4"	1/4"	1"

DOUBLE-LIP WIPER SEAL



STANDARD SIZES

SHAFT SIZE	PART NUMBER	OUTSIDE DIAMETER	PLATE THICKNESS	OVER-ALL SEAL HEIGHT
1/2"	CB-82012	1 1/2"	3/32"	1/2"
3/4"	CB-82034	1 3/4"	3/32"	1/2"
1"	CB-82100	2"	3/32"	1/2"

CHICAGO-ALLIS FLANGE PACKING

For piston rods as seals or wipers

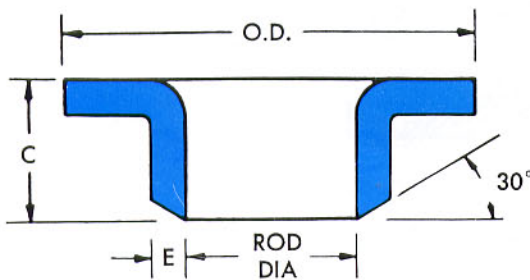
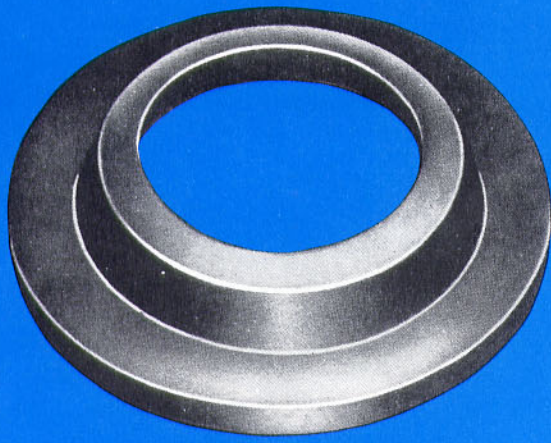

STANDARD SIZES — LEATHER

D-14 DASH NO.	I.D.	C	E	RECOMMENDED O.D.
12	1/2	5/16	1/16	1 1/4
14	3/8	5/16	1/16	1 3/8
16	3/4	5/16	1/16	1 1/2
18	7/8	5/16	1/16	1 5/8
20	1	3/8	3/32	2
22	1 1/8	3/8	3/32	2 1/8
24	1 1/4	3/8	3/32	2 1/4
26	1 3/8	3/8	3/32	2 3/8
27	1 1/2	3/8	3/32	2 1/2
28	1 5/8	3/8	3/32	2 5/8
29	1 3/4	3/8	3/32	2 3/4
30	1 7/8	7/16	1/8	3
31	2	7/16	1/8	3 1/8
32	2 1/8	7/16	1/8	3 1/4
33	2 1/4	7/16	1/8	3 3/8
34	2 3/8	7/16	1/8	3 1/2
36	2 1/2	1/2	1/8	3 3/4
38	2 3/4	1/2	1/8	4
40	3	1/2	1/8	4 1/4
42	3 1/4	1/2	1/8	4 1/2
44	3 1/2	1/2	1/8	4 3/4
46	3 3/4	1/2	1/8	5
49	4	5/8	3/32	5 5/8
50	4 1/4	5/8	3/32	5 5/8
51	4 1/2	5/8	3/32	6 1/8
52	4 3/4	5/8	3/32	6 3/8
53	5	5/8	3/32	6 5/8
54	5 1/4	5/8	3/32	6 7/8
55	5 1/2	5/8	3/32	7 1/8

NOTES:

1. The above are standard commercial sizes recommended for new designs. Other sizes for equipment already in use are available.
2. Leather V Packings are recommended when rod diameters exceed 5 1/2 inches.
3. Specifications on this chart are for leather only.

Sealing on the inside diameter only, the hat-shaped flange packing is primarily used for low pressure, outside-packed installations where lack of space precludes the use of Vee or "U" packing. Flange packing is used to retain gas or fluid, pressure or to seal out dust or foreign matter for either reciprocating or rotating motions. Most commonly made of leather, flange packings are also available in homogeneous rubber and fabric upon application. The tannages of the leather and impregnations are selected according to the specific operating conditions of temperature, pressure, and medium.

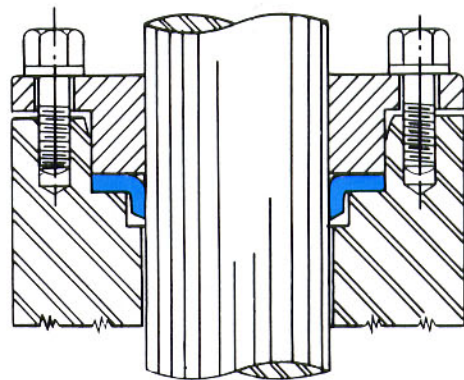

CHICAGO-ALLIS "O" RINGS & BACK-UP WASHERS

For reciprocating shafts and pistons. Pressures to 1500 P. S. I.

wide variety of synthetic rubbers for accommodating the multitude of operating conditions of pressures, temperatures, and mediums.

Back up washers of leather and teflon are used in static and reciprocating applications wherein the pressures exceed 1500 P.S.I. Without the back-up or "anti-extrusion" washer the "O" ring would likely extrude and cause premature failure. Back up washers are available in most "O" ring sizes.

"O" ring packings function under the principle of controlled deformation to cause the sealing action. They are widely used as static and reciprocating seals in conjunction with hydraulics, pneumatics and other mediums of operation. Upon proper application, "O" rings have been successfully used as oscillating and rotating seals. "O" rings are available in a

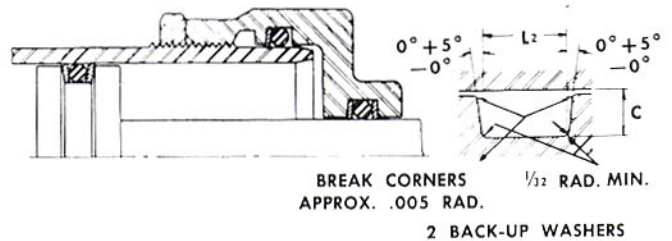
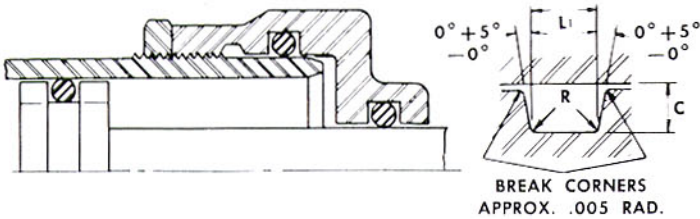

GROOVE SPECIFICATIONS FOR "O" RINGS

ARP-10 DASH NO.	PACKING SECTION DIAMETER	C GLAND WIDTH MIN.	DIAMETRAL CLEARANCE MAXIMUM	ECCEN- TRICITY MAXIMUM	WITHOUT BACK-UP WASHERS			WITH BACK-UP WASHERS	
					CROSS- SECTION DIAMETRAL SQUEEZE MINIMUM	L1 GROOVE LENGTH	R RADIUS	CROSS- SECTION DIAMETRAL SQUEEZE MINIMUM	L2 GROOVE LENGTH +.005 -.000
004-045	.070 ± .003	.057	.005	.002	.010	.094	.016	.010	.205
110-163	.103 ± .003	.090	.005	.002	.010	.141	.016	.010	.238
210-281	.139 ± .004	.123	.006	.003	.012	.188	.031	.012	.275
325-349	.210 ± .005	.188	.007	.004	.017	.281	.047	.017	.410
425-460	.275 ± .006	.240	.008	.005	.029	.375	.063	.027	.538

Proportions

NOM. CS	1/16	3/32	1/8	3/16	1/4
Act. CS	.070 ± .003	.103 ± .003	.139 ± .004	.210 ± .005	.275 ± .006

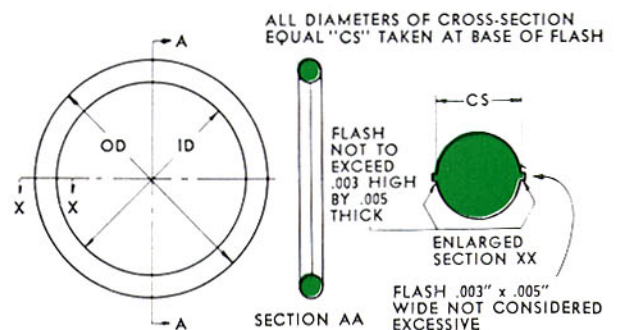

New Uniform Number System Same As ARP 568	Nominal Size			Actual Size		New Uniform Number System Same As ARP 568	Nominal Size			Actual Size		New Uniform Number System Same As ARP 568	Nominal Size			Actual Size	
	I.D.	O.D.	C.S. Diam.	C.S. Diam.	I.D.		I.D.	O.D.	C.S. Diam.	C.S. Diam.	I.D.		I.D.	O.D.	C.S. Diam.	C.S. Diam.	I.D.
004	—	—	—	.070 ± .003	.070 ± .004	144	2 1/2	2 1/16	3/32	.103 ± .003	2.487 ± .010	266	8	8 1/4	1/8	.139 ± .004	7.984 ± .030
005	—	—	—	.070 ± .003	.101 ± .004	145	2 5/8	2 3/4	3/32	.103 ± .003	2.550 ± .010	267	8 1/4	8 3/4	1/8	.139 ± .004	8.234 ± .030
006	1/8	1/4	1/16	.070 ± .003	.114 ± .005	146	2 3/8	2 13/16	3/32	.103 ± .003	2.612 ± .010	268	8 1/2	8 5/8	1/8	.139 ± .004	8.484 ± .030
007	3/32	3/16	1/16	.070 ± .003	.145 ± .005	147	2 11/16	2 7/8	3/32	.103 ± .003	2.675 ± .015	269	8 3/4	9	1/8	.139 ± .004	8.734 ± .030
008	3/16	5/16	1/16	.070 ± .003	.176 ± .005	148	2 3/4	2 5/8	3/32	.103 ± .003	2.737 ± .015	270	9	9 1/4	1/8	.139 ± .004	8.984 ± .030
009	3/16	11/32	1/16	.070 ± .003	.208 ± .005	149	2 13/16	3	3/32	.103 ± .003	2.800 ± .015	271	9 1/4	9 1/2	1/8	.139 ± .004	9.234 ± .030
010	1/4	3/8	1/16	.070 ± .003	.239 ± .005	150	2 7/8	3 1/16	3/32	.103 ± .003	2.862 ± .015	272	9 1/2	9 3/4	1/8	.139 ± .004	9.484 ± .030
011	3/16	7/16	1/16	.070 ± .003	.301 ± .005	151	3	3 3/16	3/32	.103 ± .003	2.987 ± .015	273	9 3/4	10	1/8	.139 ± .004	9.734 ± .030
012	3/8	1/2	1/16	.070 ± .003	.364 ± .005	152	3 1/4	3 3/16	3/32	.103 ± .003	3.237 ± .015	274	10	10 1/4	1/8	.139 ± .004	9.984 ± .030
013	3/16	7/16	1/16	.070 ± .003	.426 ± .005	153	3 1/2	3 11/16	3/32	.103 ± .003	3.487 ± .015	275	10 1/2	10 3/4	1/8	.139 ± .004	10.484 ± .030
014	1/2	5/8	1/16	.070 ± .003	.489 ± .005	154	3 3/4	3 5/8	3/32	.103 ± .003	3.737 ± .015	276	11	11 1/4	1/8	.139 ± .004	10.984 ± .030
015	5/16	11/16	1/16	.070 ± .003	.551 ± .005	155	4	4 3/16	3/32	.103 ± .003	3.987 ± .015	277	11 1/2	11 3/4	1/8	.139 ± .004	11.484 ± .030
016	3/8	3/4	1/16	.070 ± .003	.614 ± .005	156	4 1/4	4 1/4	3/32	.103 ± .003	4.237 ± .015	278	12	12 1/4	1/8	.139 ± .004	11.984 ± .030
017	11/16	13/16	1/16	.070 ± .003	.676 ± .005	157	4 1/2	4 11/16	3/32	.103 ± .003	4.487 ± .015	279	13	13 1/4	1/8	.139 ± .004	12.984 ± .030
018	3/4	7/8	1/16	.070 ± .003	.739 ± .005	158	4 3/4	4 5/8	3/32	.103 ± .003	4.737 ± .015	280	14	14 1/4	1/8	.139 ± .004	13.984 ± .030
019	13/16	15/16	1/16	.070 ± .003	.801 ± .006	159	5	5 1/16	3/32	.103 ± .003	4.987 ± .015	281	15	15 1/4	1/8	.139 ± .004	14.984 ± .030
020	7/8	1	1/16	.070 ± .003	.864 ± .006	160	5 1/4	5 1/8	3/32	.103 ± .003	5.237 ± .023	325	1 1/2	1 7/8	3/16	.210 ± .005	1.475 ± .010
021	15/16	1 1/16	1/16	.070 ± .003	.926 ± .006	161	5 1/2	5 11/16	3/32	.103 ± .003	5.487 ± .023	326	1 3/4	2	3/16	.210 ± .005	1.600 ± .010
022	1	1 1/8	1/16	.070 ± .003	.989 ± .006	162	5 3/4	5 5/8	3/32	.103 ± .003	5.737 ± .023	327	1 3/4	2 1/8	3/16	.210 ± .005	1.725 ± .010
023	1 1/16	1 3/16	1/16	.070 ± .003	1.051 ± .006	163	6	6 3/16	3/32	.103 ± .003	5.987 ± .023	328	1 7/8	2 1/4	3/16	.210 ± .005	1.850 ± .010
024	1 1/8	1 1/4	1/16	.070 ± .003	1.114 ± .006	210	3/4	1	1/8	.139 ± .004	.734 ± .006	329	2	2 3/8	3/16	.210 ± .005	1.975 ± .010
025	1 3/16	1 3/8	1/16	.070 ± .003	1.176 ± .006	211	13/16	1 1/16	1/8	.139 ± .004	.796 ± .006	330	2 1/8	2 1/2	3/16	.210 ± .005	2.100 ± .010
026	1 1/4	1 3/8	1/16	.070 ± .003	1.239 ± .006	212	7/8	1 1/8	1/8	.139 ± .004	.859 ± .006	331	2 1/4	2 3/8	3/16	.210 ± .005	2.225 ± .010
027	1 3/16	1 7/16	1/16	.070 ± .003	1.301 ± .006	213	15/16	1 3/16	1/8	.139 ± .004	.921 ± .006	332	2 3/8	2 3/4	3/16	.210 ± .005	2.350 ± .010
028	1 3/8	1 1/2	1/16	.070 ± .003	1.364 ± .006	214	1	1 1/4	1/8	.139 ± .004	.984 ± .006	333	2 1/2	2 7/8	3/16	.210 ± .005	2.475 ± .010
029	1 1/2	1 5/8	1/16	.070 ± .003	1.489 ± .010	215	1 1/16	1 3/8	1/8	.139 ± .004	1.046 ± .006	334	2 3/4	3	3/16	.210 ± .005	2.600 ± .010
030	1 3/4	1 3/4	1/16	.070 ± .003	1.614 ± .010	216	1 1/8	1 3/8	1/8	.139 ± .004	1.109 ± .006	335	2 5/8	3 1/8	3/16	.210 ± .005	2.725 ± .015
031	1 3/4	1 7/8	1/16	.070 ± .003	1.739 ± .010	217	1 3/16	1 7/8	1/8	.139 ± .004	1.171 ± .006	336	2 7/8	3 1/4	3/16	.210 ± .005	2.850 ± .015
032	1 7/8	2	1/16	.070 ± .003	1.864 ± .010	218	1 1/4	1 1/2	1/8	.139 ± .004	1.234 ± .006	337	3	3 3/8	3/16	.210 ± .005	2.975 ± .015
033	2	2 1/8	1/16	.070 ± .003	1.989 ± .010	219	1 3/16	1 5/8	1/8	.139 ± .004	1.296 ± .006	338	3 3/8	3 3/2	3/16	.210 ± .005	3.100 ± .015
034	2 1/8	2 1/4	1/16	.070 ± .003	2.114 ± .010	220	1 3/8	1 5/8	1/8	.139 ± .004	1.359 ± .006	339	3 3/4	3 3/8	3/16	.210 ± .005	3.225 ± .015
035	2 1/4	2 3/8	1/16	.070 ± .003	2.239 ± .010	221	1 7/16	1 11/16	1/8	.139 ± .004	1.421 ± .006	340	3 3/8	3 3/4	3/16	.210 ± .005	3.350 ± .015
036	2 3/8	2 1/2	1/16	.070 ± .003	2.364 ± .010	222	1 1/2	1 3/4	1/8	.139 ± .004	1.484 ± .006	341	3 3/2	3 3/8	3/16	.210 ± .005	3.475 ± .015
037	2 1/2	2 5/8	1/16	.070 ± .003	2.489 ± .010	223	1 5/8	1 7/8	1/8	.139 ± .004	1.609 ± .010	342	3 3/8	4	3/16	.210 ± .005	3.600 ± .015
038	2 5/8	2 3/4	1/16	.070 ± .003	2.614 ± .010	224	1 3/4	2	1/8	.139 ± .004	1.734 ± .010	343	3 3/4	4 1/8	3/16	.210 ± .005	3.725 ± .015
039	2 3/4	2 7/8	1/16	.070 ± .003	2.739 ± .015	225	1 7/8	2 1/8	1/8	.139 ± .004	1.859 ± .010	344	3 7/8	4 1/4	3/16	.210 ± .005	3.850 ± .015
040	2 7/8	3	1/16	.070 ± .003	2.864 ± .015	226	2	2 1/4	1/8	.139 ± .004	1.984 ± .010	345	4	4 3/8	3/16	.210 ± .005	3.975 ± .015
041	3	3 3/8	1/16	.070 ± .003	2.989 ± .015	227	2 1/8	2 3/8	1/8	.139 ± .004	2.109 ± .010	346	4 1/8	4 1/2	3/16	.210 ± .005	4.100 ± .015
042	3 1/4	3 3/8	1/16	.070 ± .003	3.239 ± .015	228	2 1/4	2 1/2	1/8	.139 ± .004	2.234 ± .010	347	4 1/4	4 3/8	3/16	.210 ± .005	4.225 ± .015
043	3 1/2	3 3/8	1/16	.070 ± .003	3.489 ± .015	229	2 3/8	2 5/8	1/8	.139 ± .004	2.359 ± .010	348	4 3/8	4 3/4	3/16	.210 ± .005	4.350 ± .015
044	3 3/4	3 3/8	1/16	.070 ± .003	3.739 ± .015	230	2 1/2	2 3/4	1/8	.139 ± .004	2.484 ± .010	349	4 1/2	4 7/8	3/16	.210 ± .005	4.475 ± .015
045	4	4 1/8	1/16	.070 ± .003	3.989 ± .015	231	2 3/8	2 7/8	1/8	.139 ± .004	2.609 ± .010	425	4 1/2	5	1/4	.275 ± .006	4.475 ± .015
110	3/8	3/16	3/32	.103 ± .003	.362 ± .005	232	2 3/4	3	1/8	.139 ± .004	2.734 ± .015	426	4 3/8	5 1/8	1/4	.275 ± .006	4.600 ± .015
111	7/16	5/8	3/32	.103 ± .003	.424 ± .005	233	2 3/8	3 1/8	1/8	.139 ± .004	2.859 ± .015	427	4 3/4	5 1/4	1/4	.275 ± .006	4.725 ± .015
112	1/2	11/16	3/32	.103 ± .003	.487 ± .005	234	3	3 1/4	1/8	.139 ± .004	2.984 ± .015	428	4 7/8	5 3/8	1/4	.275 ± .006	4.850 ± .015
113	9/16	3/4	3/32	.103 ± .003	.549 ± .005	235	3 1/8	3 3/8	1/8	.139 ± .004	3.109 ± .015	429	5	5 1/2	1/4	.275 ± .006	4.975 ± .015
114	5/8	13/16	3/32	.103 ± .003	.612 ± .005	236	3 1/4	3 1/2	1/8	.139 ± .004	3.234 ± .015	430	5 1/8	5 3/8	1/4	.275 ± .006	5.100 ± .023
115	11/16	7/8	3/32	.103 ± .003	.674 ± .005	237	3 3/8	3 3/8	1/8	.139 ± .004	3.359 ± .015	431	5 1/4	5 3/4	1/4	.275 ± .006	5.225 ± .023
116	3/4	15/16	3/32	.103 ± .003	.737 ± .005	238	3 1/2	3 3/4	1/8	.139 ± .004	3.484 ± .015	432	5 3/8	5 3/4	1/4	.275 ± .006	5.350 ± .023
117	13/16	1	3/32	.103 ± .003	.799 ± .006	239	3 3/8	3 3/8	1/8	.139 ± .004	3.609 ± .015	433	5 1/2	6	1/4	.275 ± .006	5.475 ± .023
118	7/8	1 1/16	3/32	.103 ± .003	.862 ± .006	240	3 3/4	4	1/8	.139 ± .004	3.734 ± .015	434	5 5/8	6 1/8	1/4	.275 ± .006	5.600 ± .023
119	15/16	1 1/8	3/32	.103 ± .003	.924 ± .006	241	3 7/8	4 1/8	1/8	.139 ± .004	3.859 ± .015	435	5 3/4	6 1/4	1/4	.275 ± .006	5.725 ± .023
120	1	1 3/16	3/32	.103 ± .003	.987 ± .006	242	4	4 1/4	1/8	.139 ± .004	3.984 ± .015	436	5 7/8	6 3/8	1/4	.275 ± .006	5.850 ± .023
121	1 1/16	1 1/4	3/32	.103 ± .003	1.049 ± .006	243	4 1/8	4 3/8	1/8	.139 ± .004	4.109 ± .015	437	6	6 1/2	1/4	.275 ± .006	5.975 ± .023
122	1 1/8	1 3/8	3/32	.103 ± .003	1.112 ± .006	244	4 1/4	4 1/2	1/8	.139 ± .004	4.234 ± .015	438	6 1/4	6 3/4	1/4	.275 ± .006	6.225 ± .023
123	1 3/8	1 3/4	3/32	.103 ± .003	1.174 ± .006	245	4 3/8	4 3/8	1/8	.139 ± .004	4.359 ± .015	439	6 1/2	7	1/4	.275 ± .006	6.475 ± .023
124	1 1/4	1 7/8	3/32	.103 ± .003	1.237 ± .006	246	4 1/2	4 3/4	1/8	.139 ± .004	4.484 ± .015	440	6 3/4	7 1/4	1/4	.275 ± .006	6.725 ± .023
125	1 3/16	1 1/2	3/32	.103 ± .003	1.299 ± .006	247	4 3/8	4 7/8	1/8	.139 ± .004	4.609 ± .015	441	7	7 1/2	1/4	.275 ± .006	6.975 ± .023
126	1 3/8	1 5/8	3/32	.103 ± .003	1.362 ± .006	248	4 3/4	5	1/8	.139 ± .004	4.734 ± .015	442	7 1/4	7 3/4	1/4	.275 ± .006	7.225 ± .030
127	1 3/16	1 5/8	3/32	.103 ± .003	1.424 ± .006	249	4 7/8	5 1/8	1/8	.139 ± .004	4.859 ± .015	443	7 1/2	8	1/4	.275 ± .006	7.475 ± .030
128	1 1/2	1 11/16	3/32	.103 ± .003	1.487 ± .006	250	5	5 1/4	1/8	.139 ± .004	4.984 ± .015	444	7 3/4	8 1/4	1/4	.275 ± .006	7.725 ± .030
129	1 5/8	1 3/4	3/32	.103 ± .003	1.549 ± .010	251	5 1/8	5 3/8	1/8	.139 ± .004	5.109 ± .023	445	8				

CHICAGO-ALLIS

CASTHANE®

POLYURETHANE

and
BUNA-N

STANDARD WIPER RINGS

Interchange with AN-6231 and MS-28766 wipers

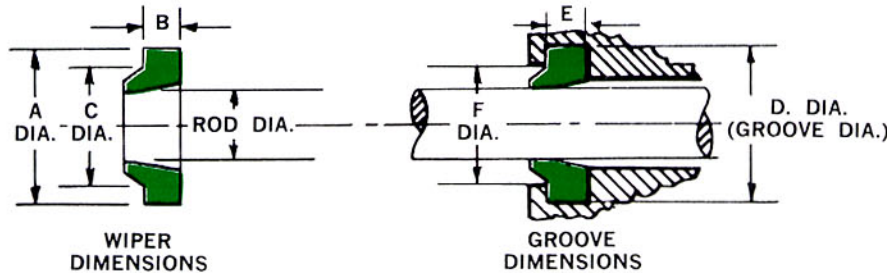

D-31 Dash No.	Rod Dia.	Wiper Dimensions			Groove Dimensions		
		A Outer Dia.	B Base Thickness	C Dia.	D ±.003	E ±.003	F ±.005
012	.500	.766	.104	.623	.769	.107	.628
0916	.562	.829	.104	.686	.832	.107	.691
058	.625	.891	.104	.748	.894	.107	.753
01116	.688	.954	.104	.810	.957	.107	.815
034	.750	1.016	.104	.873	1.019	.107	.878
01316	.812	1.059	.104	.926	1.062	.107	.931
078	.875	1.121	.104	.989	1.124	.107	.994
01516	.938	1.184	.104	1.051	1.187	.107	1.056
100	1.000	1.246	.104	1.113	1.249	.107	1.118
1116	1.062	1.309	.104	1.176	1.312	.107	1.181
118	1.125	1.371	.104	1.239	1.374	.107	1.244
1316	1.188	1.434	.104	1.301	1.437	.107	1.306
114	1.250	1.496	.104	1.363	1.499	.107	1.368
1516	1.312	1.621	.104	1.457	1.624	.107	1.462
138	1.375	1.684	.104	1.519	1.687	.107	1.524
1716	1.438	1.746	.104	1.582	1.749	.107	1.587
112	1.500	1.809	.104	1.645	1.812	.107	1.650
158	1.625	1.934	.104	1.770	1.937	.107	1.775
134	1.750	2.059	.104	1.895	2.062	.107	1.900
178	1.875	2.184	.104	2.020	2.187	.107	2.025
200	2.000	2.309	.104	2.145	2.312	.107	2.150
218	2.125	2.434	.104	2.270	2.437	.107	2.275
214	2.250	2.559	.104	2.395	2.562	.107	2.400
238	2.375	2.684	.104	2.520	2.687	.107	2.525
212	2.500	2.809	.104	2.645	2.812	.107	2.650
258	2.625	2.996	.119	2.801	2.999	.122	2.806
234	2.750	3.121	.119	2.926	3.124	.122	2.931
278	2.875	3.246	.119	3.051	3.249	.122	3.056
300	3.000	3.372	.119	3.177	3.375	.122	3.182
318	3.125	3.497	.119	3.302	3.500	.122	3.307
314	3.250	3.622	.119	3.427	3.625	.122	3.432
338	3.375	3.747	.119	3.552	3.750	.122	3.557
312	3.500	3.872	.119	3.677	3.875	.122	3.682

D-31 Dash No.	Rod Dia.	Wiper Dimensions			Groove Dimensions		
		A Outer Dia.	B Base Thickness	C Dia.	D ±.005	E ±.003	F ±.005
358	3.625	3.997	.119	3.802	4.002	.122	3.807
334	3.750	4.122	.119	3.927	4.127	.122	3.932
378	3.875	4.247	.119	4.052	4.252	.122	4.057
400	4.000	4.435	.135	4.208	4.440	.138	4.213
418	4.125	4.560	.135	4.333	4.565	.138	4.338
414	4.250	4.685	.135	4.458	4.690	.138	4.463
438	4.375	4.810	.135	4.583	4.815	.138	4.588
412	4.500	4.935	.135	4.708	4.940	.138	4.713
458	4.625	5.060	.135	4.833	5.065	.138	4.838
434	4.750	5.185	.135	4.958	5.190	.138	4.963
478	4.875	5.310	.135	5.083	5.315	.138	5.088
500	5.000	5.435	.135	5.208	5.440	.138	5.213
518	5.125	5.560	.135	5.333	5.565	.138	5.338
514	5.250	5.685	.135	5.458	5.690	.138	5.463
538	5.375	5.810	.135	5.583	5.815	.138	5.588
512	5.500	5.935	.135	5.708	5.940	.138	5.713
558	5.625	6.122	.151	5.864	6.127	.154	5.869
534	5.750	6.247	.151	5.990	6.252	.154	5.995
578	5.875	6.372	.151	6.114	6.377	.154	6.119
600	6.000	6.497	.151	6.240	6.502	.154	6.245
614	6.250	6.747	.151	6.490	6.752	.154	6.495
612	6.500	6.997	.151	6.740	7.002	.154	6.745
634	6.750	7.247	.151	6.990	7.252	.154	6.995
700	7.000	7.497	.151	7.240	7.502	.154	7.245

CASTHANE® is the name assigned to a group of Chicago-Allis formulations of castable polyurethane. Castable polyurethane is an elastomeric material of unusual toughness and durability. From the many possible formulations of polyurethane, the Chicago-Allis CASTHANES were developed to provide the best possible combination of physical and chemical characteristics most desirable for seals, packings, and custom cast parts.

As a result of extensive research, development, and performance testing, Chicago-Allis CASTHANES have higher abrasion resistance and accommodate higher pressures far beyond the range of most elastomers. Thus, the performance and maintenance-free service life of industrial and consumer products using Chicago-Allis CASTHANE seals, packings, and custom cast parts are greatly extended.

CHICAGO-ALLIS

CASTHANE®

POLYURETHANE

and
BUNA-N

STANDARD WIPER RINGS

Interchange with AN-6231 and MS-28766 wipers

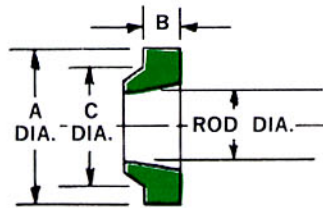

WIPER
DIMENSIONS

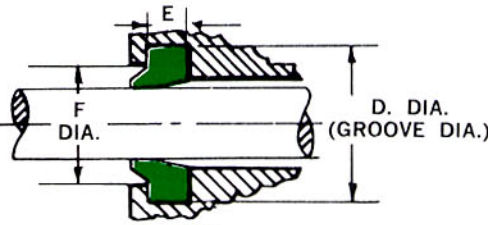

GROOVE
DIMENSIONS

D-31 Dash No.	Rod Dia.	Wiper Dimensions			Groove Dimensions		
		A Outer Dia.	B Base Thick- ness	C Dia.	D ±.003	E ±.003	F ±.005
012	.500	.766	.104	.623	.769	.107	.628
0916	.562	.829	.104	.686	.832	.107	.691
058	.625	.891	.104	.748	.894	.107	.753
01116	.688	.954	.104	.810	.957	.107	.815
034	.750	1.016	.104	.873	1.019	.107	.878
01316	.812	1.059	.104	.926	1.062	.107	.931
078	.875	1.121	.104	.989	1.124	.107	.994
01516	.938	1.184	.104	1.051	1.187	.107	1.056
100	1.000	1.246	.104	1.113	1.249	.107	1.118
1116	1.062	1.309	.104	1.176	1.312	.107	1.181
118	1.125	1.371	.104	1.239	1.374	.107	1.244
1316	1.188	1.434	.104	1.301	1.437	.107	1.306
114	1.250	1.496	.104	1.363	1.499	.107	1.368
1516	1.312	1.621	.104	1.457	1.624	.107	1.462
138	1.375	1.684	.104	1.519	1.687	.107	1.524
1716	1.438	1.746	.104	1.582	1.749	.107	1.587
112	1.500	1.809	.104	1.645	1.812	.107	1.650
158	1.625	1.934	.104	1.770	1.937	.107	1.775
134	1.750	2.059	.104	1.895	2.062	.107	1.900
178	1.875	2.184	.104	2.020	2.187	.107	2.025
200	2.000	2.309	.104	2.145	2.312	.107	2.150
218	2.125	2.434	.104	2.270	2.437	.107	2.275
214	2.250	2.559	.104	2.395	2.562	.107	2.400
238	2.375	2.684	.104	2.520	2.687	.107	2.525
212	2.500	2.809	.104	2.645	2.812	.107	2.650
258	2.625	2.996	.119	2.801	2.999	.122	2.806
234	2.750	3.121	.119	2.926	3.124	.122	2.931
278	2.875	3.246	.119	3.051	3.249	.122	3.056
300	3.000	3.372	.119	3.177	3.375	.122	3.182
318	3.125	3.497	.119	3.302	3.500	.122	3.307
314	3.250	3.622	.119	3.427	3.625	.122	3.432
338	3.375	3.747	.119	3.552	3.750	.122	3.557
312	3.500	3.872	.119	3.677	3.875	.122	3.682

D-31 Dash No.	Rod Dia.	Wiper Dimensions			Groove Dimensions		
		A Outer Dia.	B Base Thick- ness	C Dia.	D ±.005	E ±.003	F ±.005
358	3.625	3.997	.119	3.802	4.002	.122	3.807
334	3.750	4.122	.119	3.927	4.127	.122	3.932
378	3.875	4.247	.119	4.052	4.252	.122	4.057
400	4.000	4.435	.135	4.208	4.440	.138	4.213
418	4.125	4.560	.135	4.333	4.565	.138	4.338
414	4.250	4.685	.135	4.458	4.690	.138	4.463
438	4.375	4.810	.135	4.583	4.815	.138	4.588
412	4.500	4.935	.135	4.708	4.940	.138	4.713
458	4.625	5.060	.135	4.833	5.065	.138	4.838
434	4.750	5.185	.135	4.958	5.190	.138	4.963
478	4.875	5.310	.135	5.083	5.315	.138	5.088
500	5.000	5.435	.135	5.208	5.440	.138	5.213
518	5.125	5.560	.135	5.333	5.565	.138	5.338
514	5.250	5.685	.135	5.458	5.690	.138	5.463
538	5.375	5.810	.135	5.583	5.815	.138	5.588
512	5.500	5.935	.135	5.708	5.940	.138	5.713
558	5.625	6.122	.151	5.864	6.127	.154	5.869
534	5.750	6.247	.151	5.990	6.252	.154	5.995
578	5.875	6.372	.151	6.114	6.377	.154	6.119
600	6.000	6.497	.151	6.240	6.502	.154	6.245
614	6.250	6.747	.151	6.490	6.752	.154	6.495
612	6.500	6.997	.151	6.740	7.002	.154	6.745
634	6.750	7.247	.151	6.990	7.252	.154	6.995
700	7.000	7.497	.151	7.240	7.502	.154	7.245

CHICAGO-ALLIS "U" PACKING

**For pistons and rods
single or double-act-
ing. Pressures to
3000 P. S. I.**

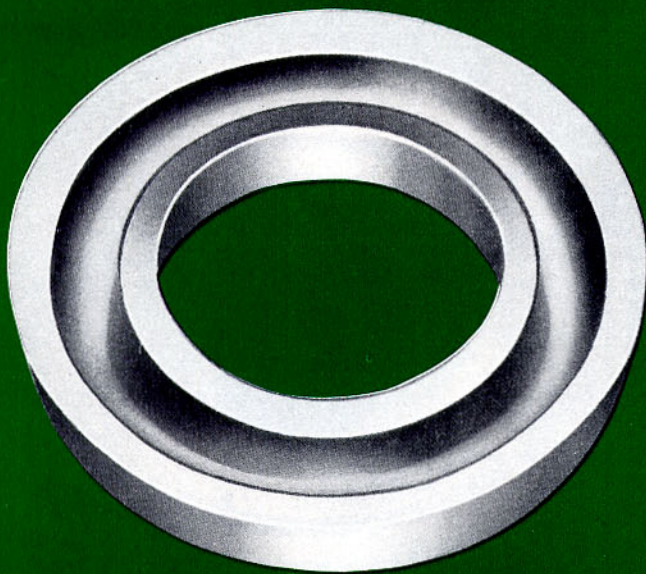

Leather "U" packings (per chart D-26-L) are primarily used to accommodate diameters and pressures beyond the capacities of homogeneous rubber "U" packings. Contact the Chicago-Allis Main Office in Chicago for complete information and recommendations on "U" packings of leather, teflon, fabric and other materials.

Homogeneous rubber "U" packings (per chart D-26-R) are most commonly used for low pressure air or hydraulic service involving a reciprocating shaft or plunger. They are automatic in action with the sealing accomplished by sensitivity to internal pressure. Used as single units for each directional pressure, two "U" packings are required for the double acting piston or cylinder.

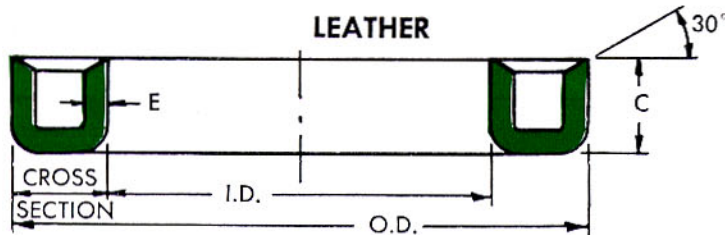

D-26-L DASH NO.	CROSS SECTION	I.D.	O.D.	C	E
12	1/4	1/2	1	5/16	1/16
14	1/4	3/8	1 1/8	5/16	1/16
16	1/4	3/4	1 1/4	5/16	1/16
18	1/4	3/8	1 3/8	5/16	1/16
20	3/8	1	1 3/4	3/8	3/32
22	3/8	1 1/8	1 7/8	3/8	3/32
24	3/8	1 1/4	2	3/8	3/32
26	3/8	1 3/8	2 1/8	3/8	3/32
27	3/8	1 1/2	2 1/4	3/8	3/32
28	3/8	1 3/8	2 3/8	3/8	3/32
29	3/8	1 3/4	2 1/2	3/8	3/32
30	1/2	1 3/8	2 3/8	7/16	1/8
31	1/2	2	3	7/16	1/8
32	1/2	2 1/8	3 1/8	7/16	1/8
33	1/2	2 1/4	3 1/4	7/16	1/8
34	1/2	2 3/8	3 3/8	7/16	1/8
36	1/2	2 1/2	3 1/2	1/2	1/8
38	1/2	2 3/4	3 3/4	1/2	1/8

D-26-L DASH NO.	CROSS SECTION	I.D.	O.D.	C	E
40	1/2	3	4	1/2	1/8
42	1/2	3 1/4	4 1/4	1/2	1/8
44	1/2	3 1/2	4 1/2	1/2	1/8
46	1/2	3 3/4	4 3/4	1/2	1/8
49	5/8	4	5 1/4	5/8	5/32
50	5/8	4 1/4	5 1/2	5/8	5/32
51	5/8	4 1/2	5 3/4	5/8	5/32
52	5/8	4 3/4	6	5/8	5/32
53	5/8	5	6 1/4	5/8	5/32
54	5/8	5 1/4	6 1/2	5/8	5/32
55	5/8	5 1/2	6 3/4	5/8	5/32
56	3/4	5 1/2	7	3/4	3/16
58	3/4	6	7 1/2	3/4	3/16
60	3/4	6 1/2	8	3/4	3/16
62	3/4	7	8 1/2	3/4	3/16
64	3/4	7 1/2	9	3/4	3/16
66	3/4	8	9 1/2	3/4	3/16
67	3/4	8 1/2	10	3/4	3/16
68	3/4	9	10 1/2	3/4	3/16
69	3/4	9 1/2	11	3/4	3/16
70	3/4	10	11 1/2	3/4	3/16
71	3/4	10 1/2	12	3/4	3/16
72	3/4	11	12 1/2	3/4	3/16
74	3/4	12	13 1/2	1	3/16
76	3/4	13	14 1/2	1	3/16
78	3/4	14	15 1/2	1	3/16
80	3/4	15	16 1/2	1	3/16

NOTE: The above are standard commercial sizes recommended for new designs. Other sizes for equipment already in use are now available.

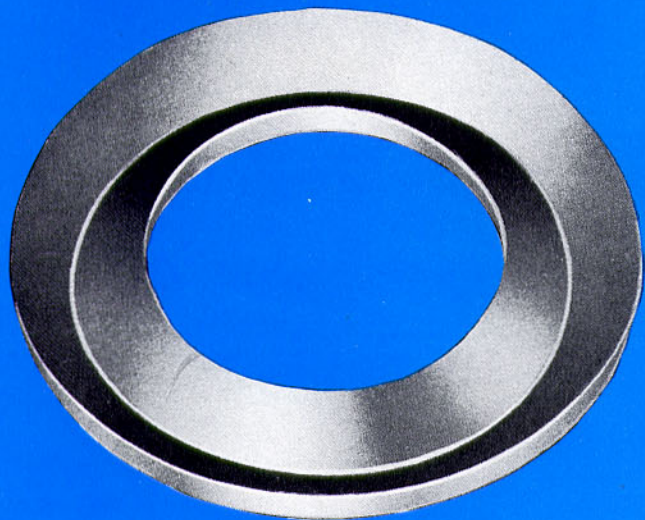

CHICAGO-ALLIS VEE PACKING

For piston rods, single or double-acting pistons, rams, and valve stems . Pressure range 0 to 30,000 P. S. I.

Vee packings can be installed on a piston (inside packed) or in a gland (outside packed). They are commonly used for single acting or double acting cylinders—and accommodate a wide variety of mediums including water, oil, solvents, corrosive chemicals, steam, air, and gas. Greater pressures are accommodated by the multiple lip sealing since Vee packings are used in nests or sets with top and bottom

adapters. The number of rings is varied depending upon the pressures and other operating conditions. Vee packings are available in leather, rubber, fabrics and teflon (upon application). Leather tannages and impregnants, type of synthetic rubber, type of fabric and impregnation depends upon the operating conditions of temperature, pressure, and medium.

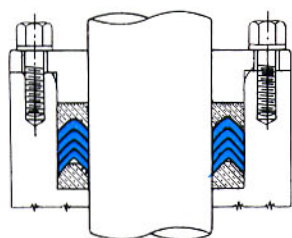
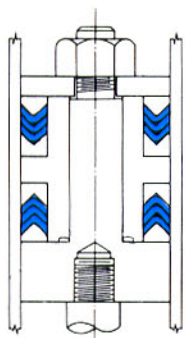
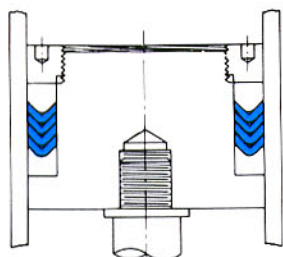
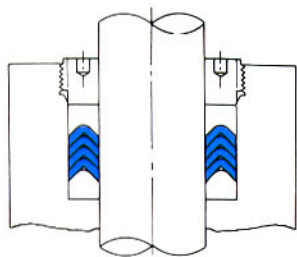

RECOMMENDED NO. OF "V" PACKINGS PER SET

PRESSURE (PSI)	TYPE OF PACKING*		
	LEATHER	HOMOGENEOUS	FABRICATED
0 to 500	3	3	3
500 to 1,500	4	4	4
1,500 to 3,000	4	5	5
3,000 to 5,000	4	6	6
5,000 to 10,000	5	—	6
Over 10,000	6	—	—

Complete interchangeability among different types or combinations of different types within a set is provided by identical stack height for each type.

ADAPTER SIZES FOR VEE PACKINGS

DASH NO.	CROSS SECTION	T*	B†	R
8 thru 24	1/4	1/4	1/8	1/16
25 thru 35	3/16	3/16	1/8	7/64
36 thru 46	3/8	3/8	1/8	1/8
49 thru 55	7/16	7/16	1/8	3/32
56 thru 80	1/2	1/2	1/8	3/32

* Standard dimensions.
† Can be any size greater than shown.

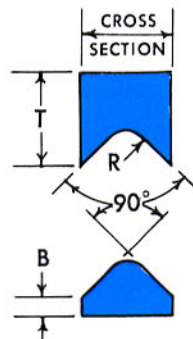

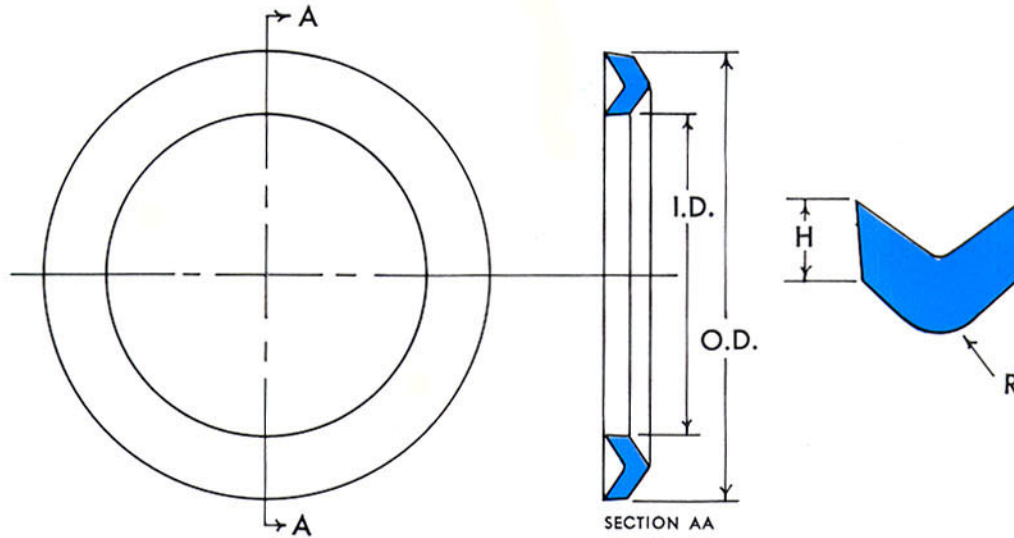

D-25 DASH NO.	CROSS SECTION	NOMINAL		H ± .010	R MIN.
		I.D.	O.D.		
8	1/4	1/4	3/4	.083	1/16
10	1/4	3/8	7/8	.083	1/16
12	1/4	1/2	1	.083	1/16
14	1/4	5/8	1-1/8	.083	1/16
16	1/4	3/4	1-1/4	.083	1/16
18	1/4	7/8	1-3/8	.083	1/16
20	1/4	1	1-1/2	.083	1/16
22	1/4	1-1/8	1-5/8	.083	1/16
24	1/4	1-1/4	1-3/4	.083	1/16
25	5/16	1-1/4	1-7/8	.140	7/64
26	5/16	1-3/8	2	.140	7/64
27	5/16	1-1/2	2-1/8	.140	7/64
28	5/16	1-5/8	2-1/4	.140	7/64
29	5/16	1-3/4	2-3/8	.140	7/64
30	5/16	1-7/8	2-1/2	.140	7/64
31	5/16	2	2-5/8	.140	7/64
32	5/16	2-1/8	2-3/4	.140	7/64
33	5/16	2-1/4	2-7/8	.140	7/64
34	5/16	2-3/8	3	.140	7/64
35	5/16	2-1/2	3-1/8	.140	7/64
36	3/8	2-1/2	3-1/4	.156	1/8
38	3/8	2-3/4	3-1/2	.156	1/8
40	3/8	3	3-3/4	.156	1/8
42	3/8	3-1/4	4	.156	1/8
44	3/8	3-1/2	4-1/4	.156	1/8

D-25 DASH NO.	CROSS SECTION	NOMINAL		H ± .010	R MIN.
		I.D.	O.D.		
46	3/8	3-3/4	4-1/2	.156	1/8
49	7/16	4	4-7/8	.197	5/32
50	7/16	4-1/4	5-1/8	.197	5/32
51	7/16	4-1/2	5-3/8	.197	5/32
52	7/16	4-3/4	5-5/8	.197	5/32
53	7/16	5	5-7/8	.197	5/32
54	7/16	5-1/4	6-1/8	.197	5/32
55	7/16	5-1/2	6-3/8	.197	5/32
56	1/2	5-1/2	6-1/2	.197	5/32
58	1/2	6	7	.197	5/32
60	1/2	6-1/2	7-1/2	.197	5/32
62	1/2	7	8	.197	5/32
64	1/2	7-1/2	8-1/2	.197	5/32
66	1/2	8	9	.197	5/32
67	1/2	8-1/2	9-1/2	.197	5/32
68	1/2	9	10	.197	5/32
69	1/2	9-1/2	10-1/2	.197	5/32
70	1/2	10	11	.197	5/32
71	1/2	10-1/2	11-1/2	.197	5/32
72	1/2	11	12	.197	5/32
74	1/2	12	13	.197	5/32
76	1/2	13	14	.197	5/32
78	1/2	14	15	.197	5/32
80	1/2	15	16	.197	5/32

Please state all operating conditions when ordering. Supplied in solid ring form unless requested split. Other sizes and thicknesses are available on request.

Under various conditions we strongly recommend use of homogeneous rubber with leather "V" Packings to achieve greater efficiency.